

folding instructions blouses: long and short sleeves

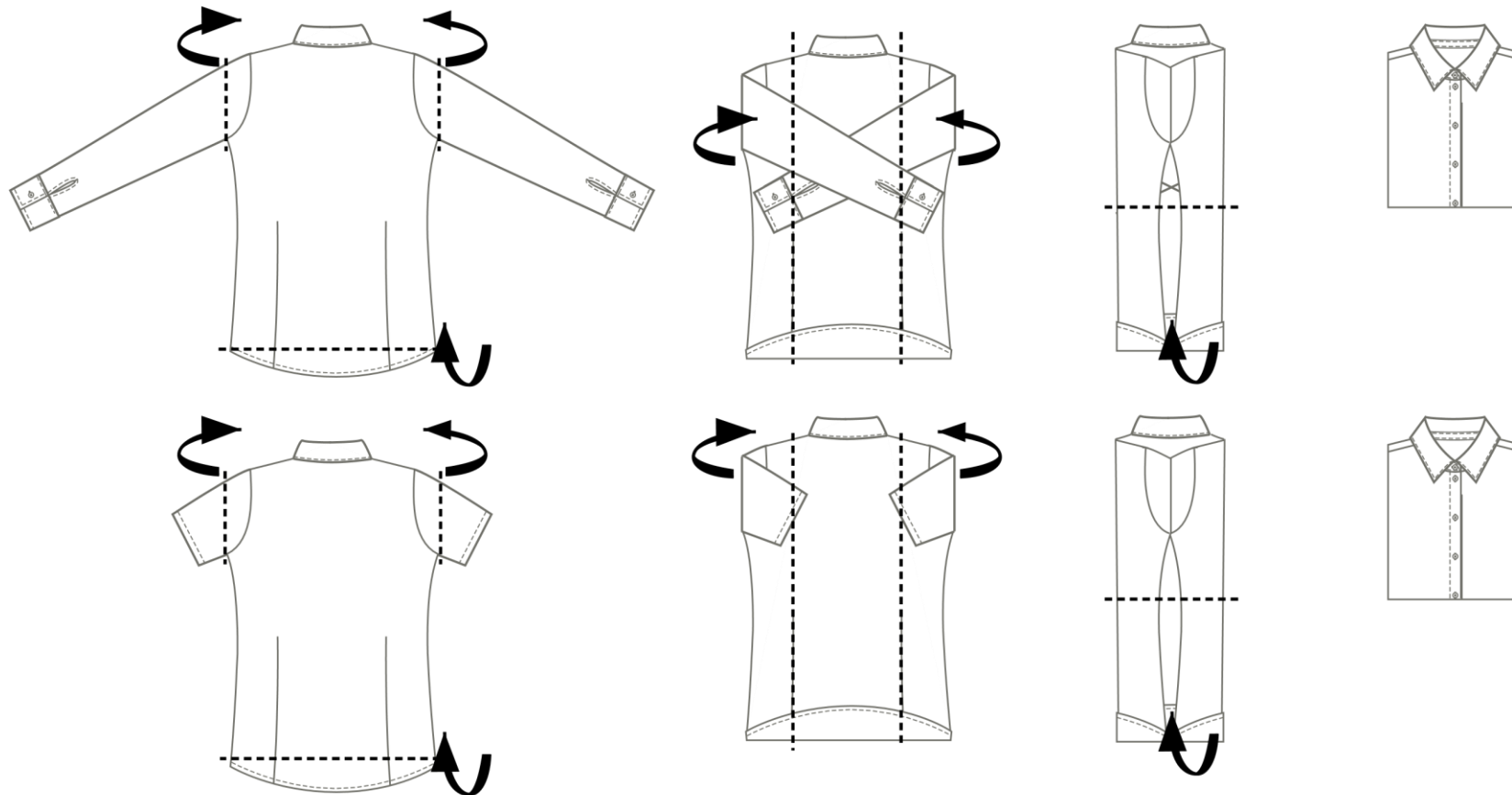

1. folded in three steps

folding instructions Pullovers / Cardigans

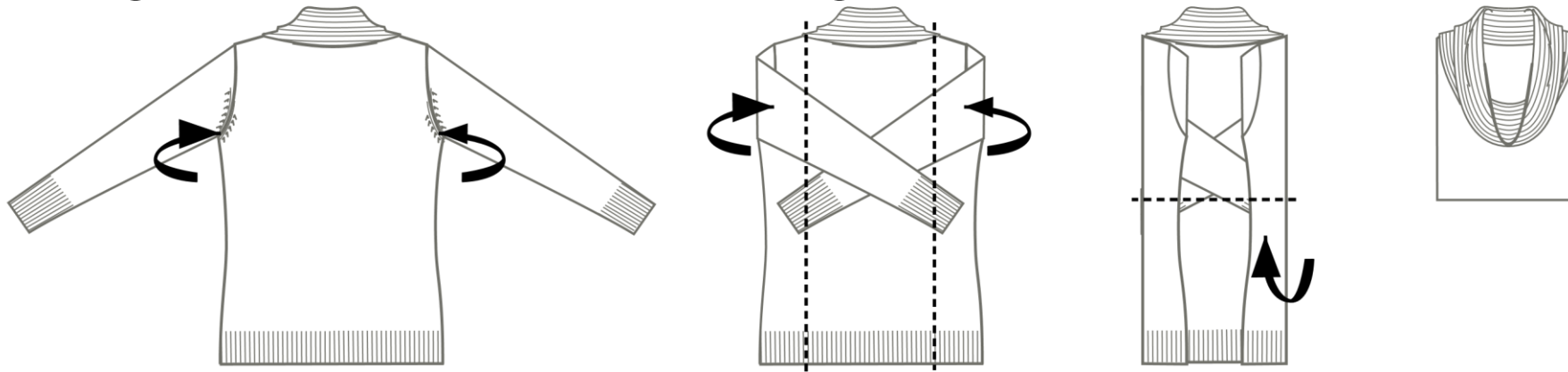

1. folded in tree steps

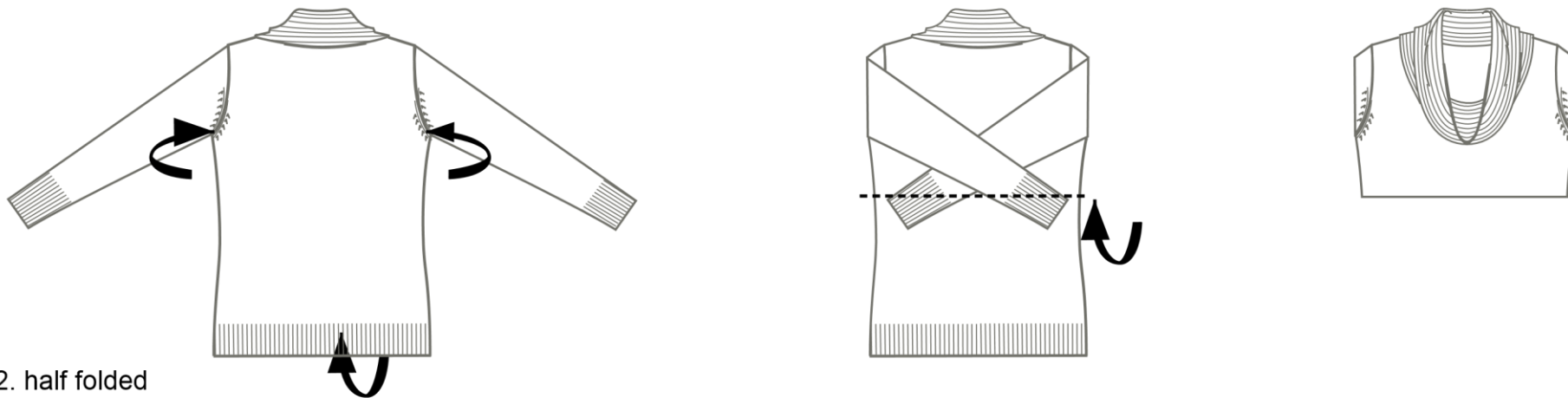

2. half folded

folding instructions sleeveless tops

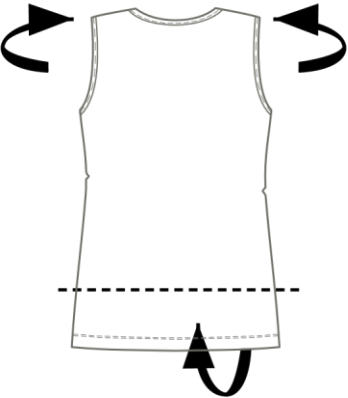

1. folded in tree steps

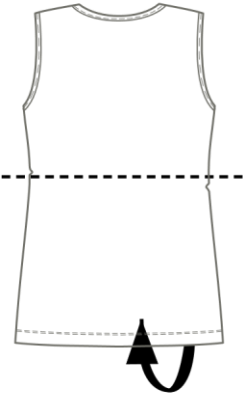
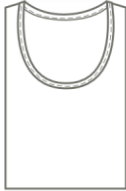
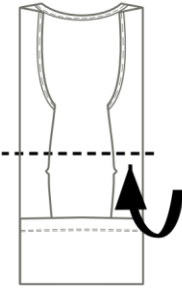
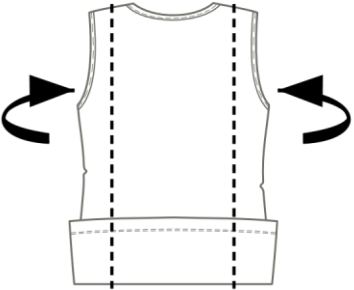

2. half folded

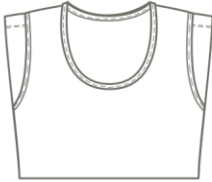

folding instructions T-shirts: long and short sleeves

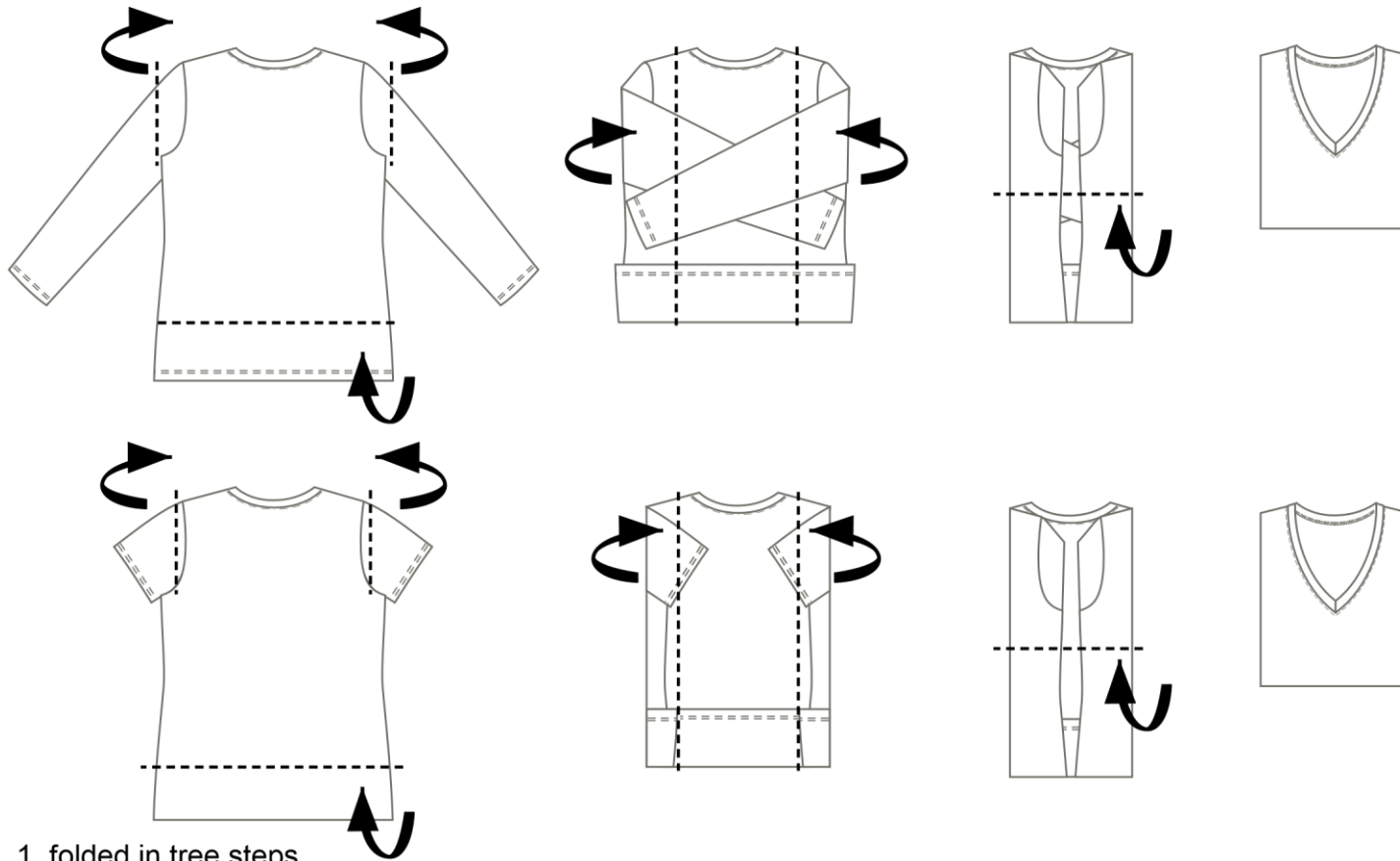

folding instructions long trousers

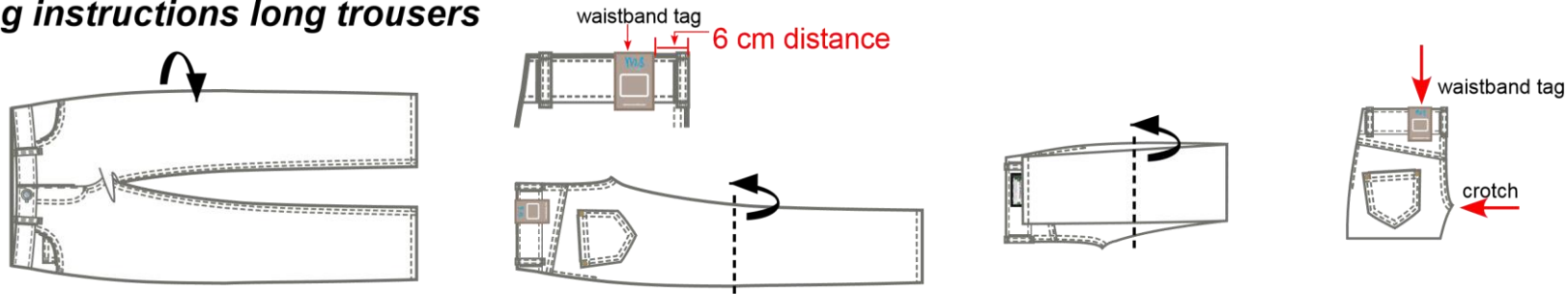

1. folded in 3 (for pre-pack and single units). Waistband tag and price sticker.

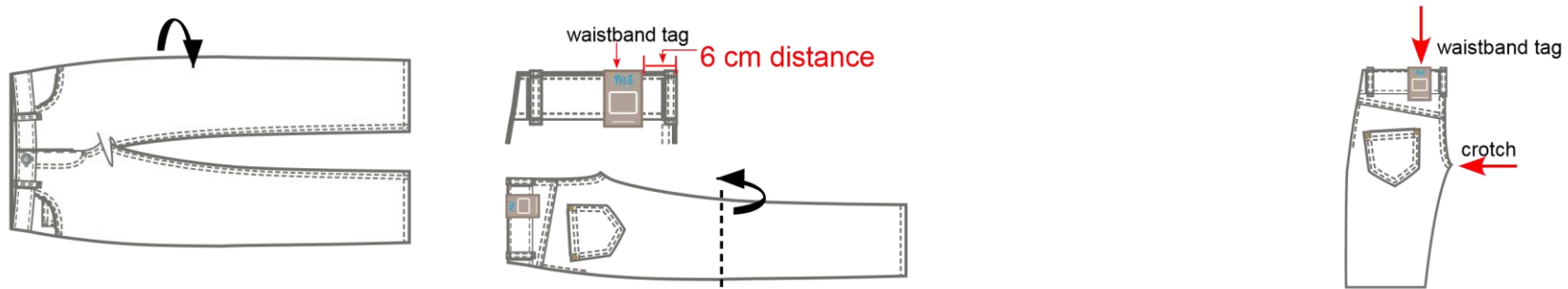

2. folded in 2 (for recon orders). Waistband tag and price sticker.

folding instructions capri's

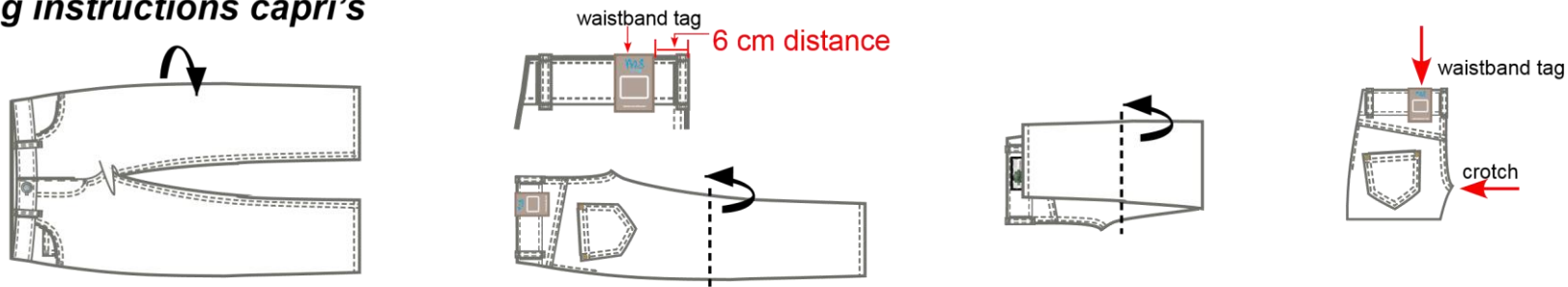

1. folded in 3 (for pre-pack and single units). Waistband tag and price sticker.

folding instructions short's

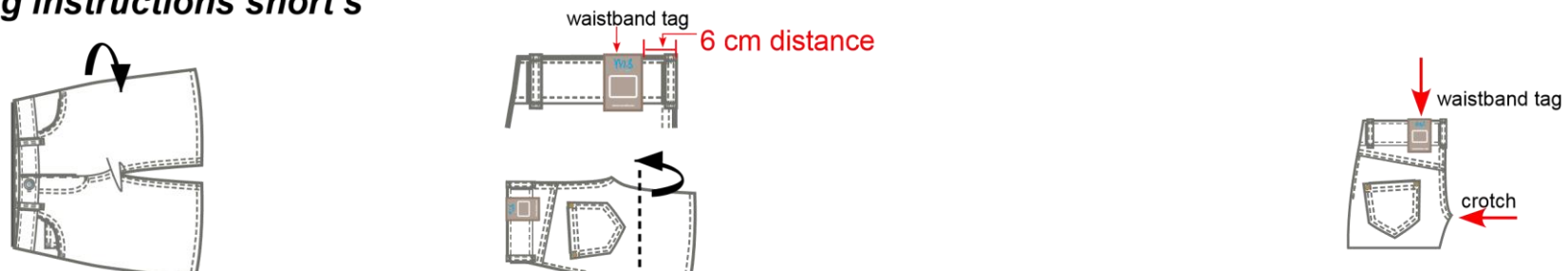

folding instructions dresses: long and short sleeves

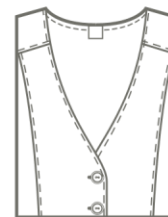
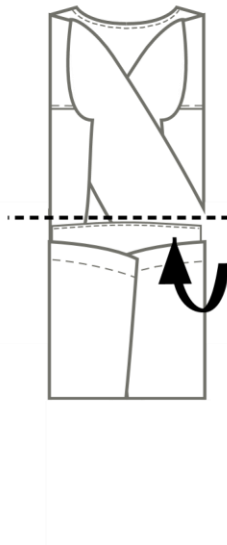
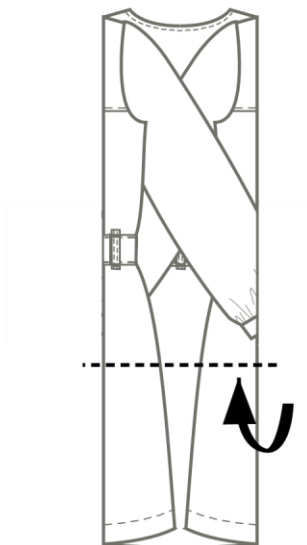

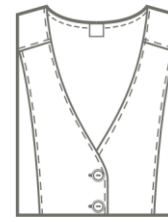
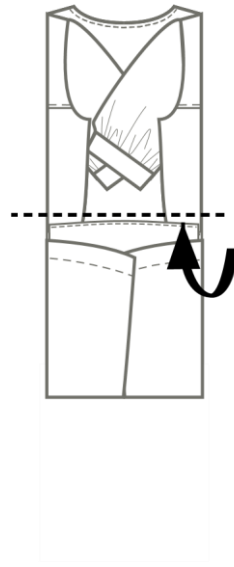
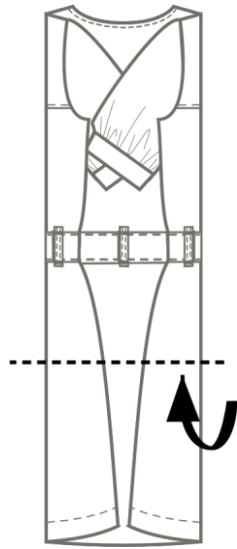
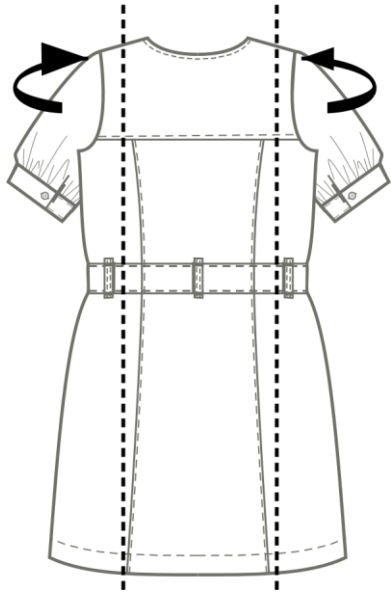

1. folded in tree steps

folding instructions long skirts

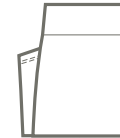
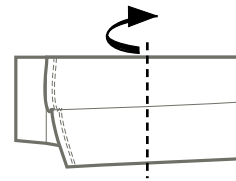
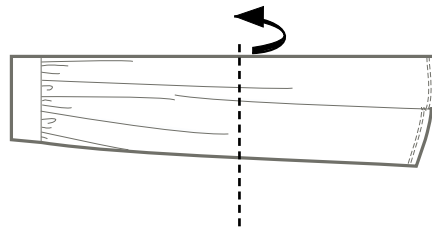
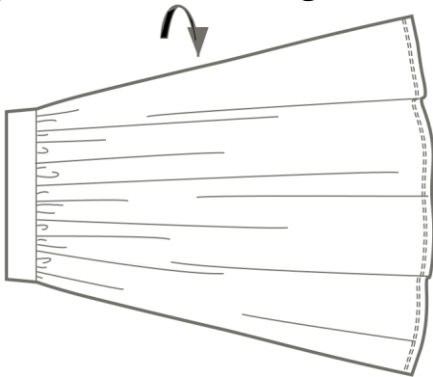

1. folded in 3 (for pre-pack and single units). Waistband tag and price sticker.

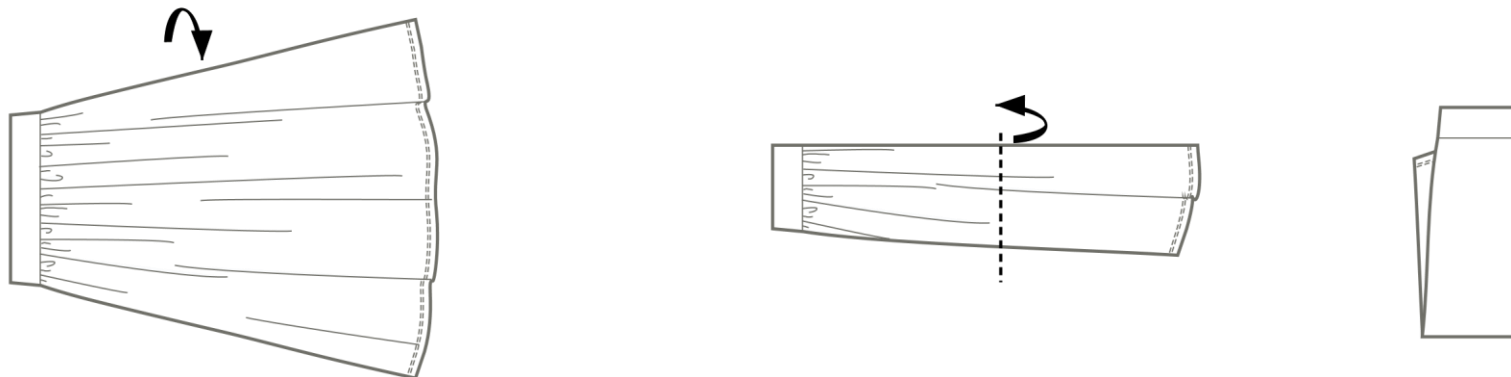

2. folded in 2 (for recon orders). Waistband tag and price sticker.

folding instructions mini/short skirts

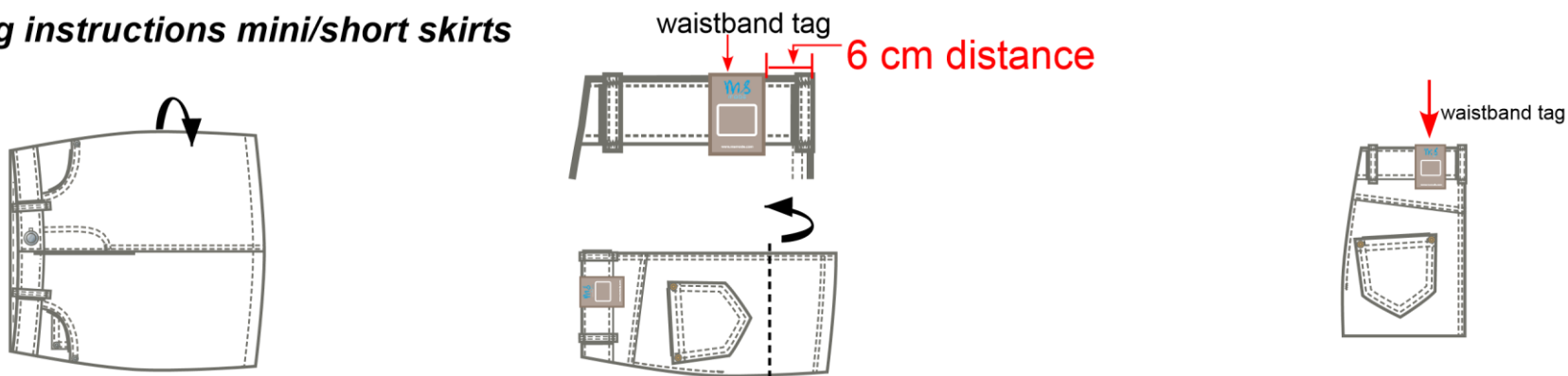

1. folded in 2 (for pre-pack and single units). Waistband tag and price sticker.



folding instructions coats / jackets

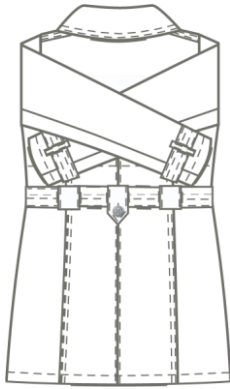
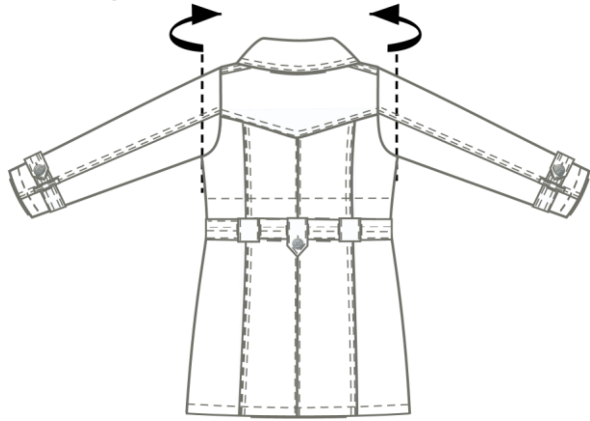

1. only fold the sleeves to the back (for packed / hanging)

folding instructions blazers

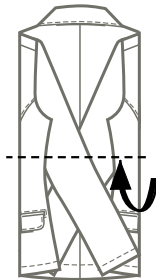
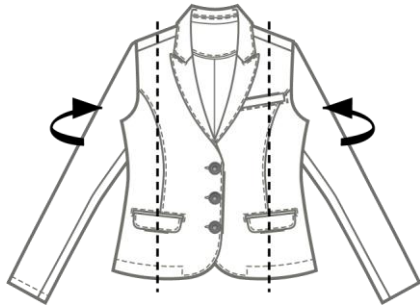

1. folded in three steps

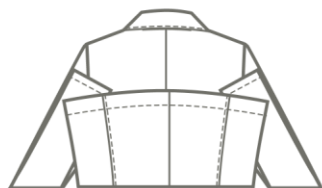
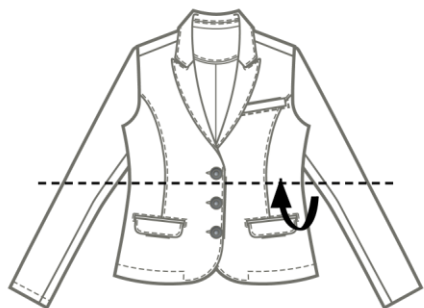

2. half folded